

Universal Wall Projector Bracket

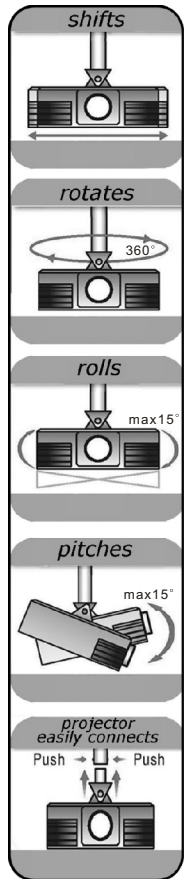
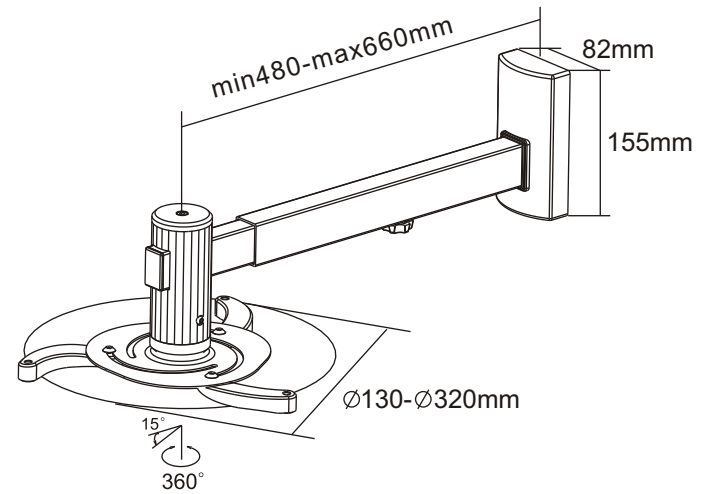
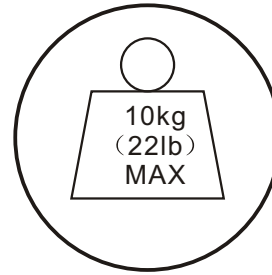

This product should be mounted to solid brick, concrete or hard wood batten / studs wall.

ASSEMBLY INSTRUCTIONS

FOR VIDEO PROJECTOR

This product is designed to mount video projector weighing up to 10kgs to wall..

Safety Warning: Be careful to make sure there are no missing or defective parts. Never use defective parts. Improper installation may cause damage or serious injury.

Note: The included hardware is for mounting on solid brick, concrete or hard wood wall. If mounting on wood, do not use any concrete anchor. If you are uncertain about the nature of your wall, consult an expert. Please consult your hardware or installation professional for proper mounting to other types or wall. The supplied hardware is not for steel.

Forbidden Instruction: Do not mount onto plasterboard or panelled wall.

Parts	Picture	Standard package	Parts	Picture	Standard package
1.Inside pipe		x1	10.Adjustable part		x3
2.Projector plate		x1	11.M6 Washer		x3
3.Dysude pipes		x1	12.5mm Allen key		x1
4.Plastic cover		x1	13.4mm Allen key		x1
5.Projector arm		x3	14.6mm Lag Bolt		x6
6. Wall plate		x1	15.Concrete Anchor		x6
7.M6 Screw		x4	16.M6 Washer		x11
8.M4 Screw		x4	17.Screw with Washer		x3
9.Adjustable part		x2	18.M6 Nut		x2
SUPPLIED PARTS: Supplied joint parts are exclusive for using in this product. Other joint parts are forbidden to use on this product. If any parts are missing or faulty, telephone the special franchiser for a placement.			19.M6 Screw		x2
			20.Knob		x1

1 FIT VIDEO. PROJECTOR

(a) COMMON MOUNTING



- Fix the projector arm (5) using screw (17).

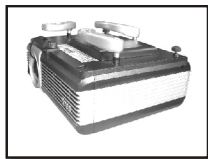

- Adjust the projector arms at the same height

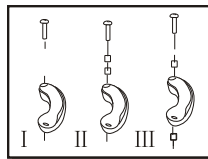

- You can choose mode I or II or III to adjust the projector arm at the same height condition on the surface of video projector.

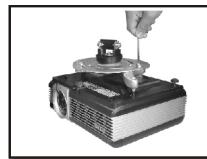

- Converge the arms to centre and fix the arms to bottom of the projector plate by using the screw M6(7), washer(11) and washer (16)

(B)SPECIAL MOUNTING

b1. For Toshiba projectors



- Connect the adjustable part (9)with video projector using M4(8)

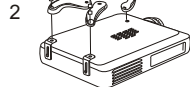

- Fix the projector arms (5) using screw(17)



- Converge the arms to centre and fix the arms to bottom of the projector plate by using the screw M6(7) washer(11)and washer(16)



- Fix the screws

b2.For phieips projectors

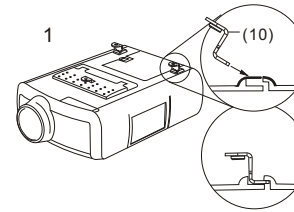

- Insert adjustable part(10) Into video projector

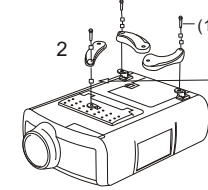

- Fix the projector legs (5) using (17)

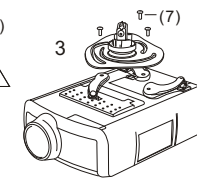

- Converge the arms to centre and fix the arms to bottom of the projector plate by using the screw M6(7) washer (11) and washer(16)

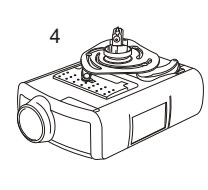

- Fix the screws

2 FIX TO WALL

(a) SOLID BRICK AND CONCRETE BLOCK WALL MOUNTING:

Use the wall plate (6) as a template to mark 6 holes locations on the wall. Pre-Drill these holes with a 8mm masonry bit to at least 50mm in depth. Insert a Concrete Anchor (15) into each of these holes, Fix the wall Plate (6) to the wall by using 6 Lag bolts (14) and washer (16).

(b) HARD WOOD CEILING MOUNTING:

Use the wall plate (6) as a template to mark 6 holes locations on the ceiling. Fix the wall Plate (6) to the wall by using for the 6 Lag Bolts (14)and washer (16).

Note: Do not use any concrete anchor when you mount the brateck onto hard wood wall.

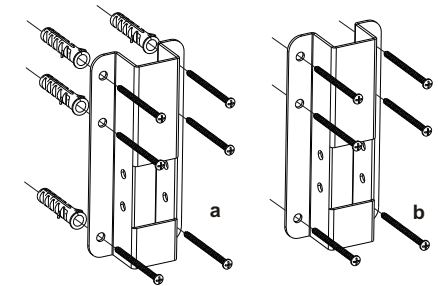

3 JOINT

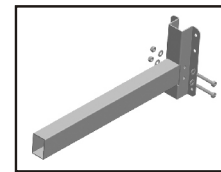

- Join the plate outside pipe (3) to the wall plate(6) by using the two screws(19),M6 Nuts(18) and M6 Washers(16).

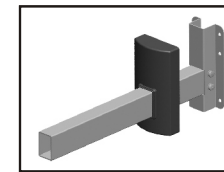

- Push the plastic cover(4) to cover the wall plate(6) completely.

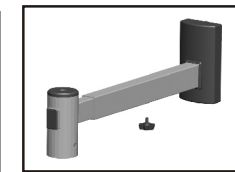

- Use the Knob(20) to connect the inside pipe(1) with the outside pipe(3) at the position you want.

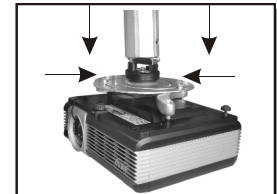

- Join the projector plate to the extension pipe pushing the two bolts at the same time

4 ADJUST



- Turn the bolts outside for the maximum safety use the allen key (13)



- Tilt the bracket as desired by working on the central part of the assembly swivel.

TENDING INSTRUCTION

Please check whether screws are fixed well each two months.

IF YOU HAVE ANY DOUBTS REGARDING INSTALLATION CONSULT OUR SPECIAL FRANCHISER.